

IMPORTANTE:
As medidas de Folgas
e Desenhos são de referência
e podem sofrer modificações.
Consulte sempre as atualizações no Site.
Este Catálogo substitui **todas** as versões anteriores.



Catálogo 2024

Versatik	Division	2
	Janela	4
	Truck	6
	Evolution	8
Safe	Duo Safe	10
	Tec Safe	12
Box	Royal Box	14
	Transfer Box	16
	Multi Box	18
Roldanas	Polímero	20
	Latão	20
OrbiTec	Sacada	22
	Pro	24
Envidraçamento	Sacada	26
FortCorp		28
Linha Completa		30



Versatik Division

A divisão de ambientes da Tec

- Ideal para pequenos e grandes vãos
- Recomendado para projetos de Arquitetura e Design de Interiores



Para Vidros de **8 e 10mm**,
Laminado ou Temperado.



Diversidade de aplicações.



Para peças de Vidro
de até **160kg**.



Instalação **simples e rápida.**



Design **minimalista.**

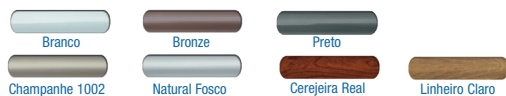

Borrachas Amortecedoras:
Contato mais suave e vedação perfeita.



Perfil Fechadura:
Perfil para Temperado ou Laminado com Fechadura embutida.



Fechamento 90°

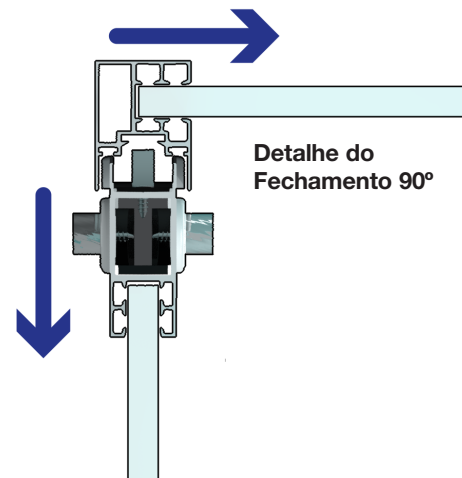

Detalhe do
Fechamento 90°

Fechamento Lateral

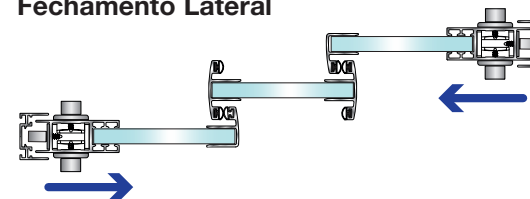

Fechamento Central

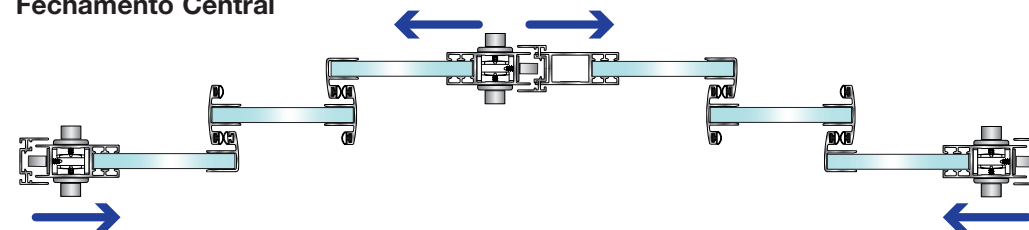

Folgas de altura

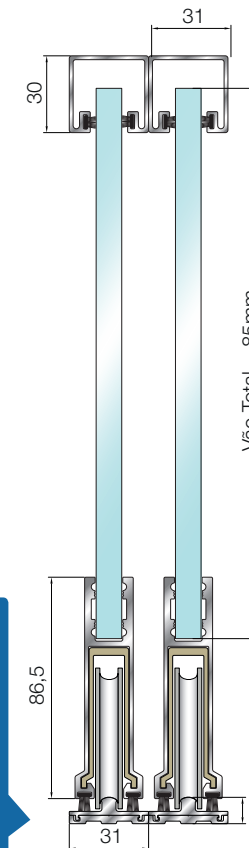

Vão Total - 85mm

Guia Inferior:
Com apenas 10mm e design exclusivo, é composta por duas peças clicáveis para ocultar os parafusos de fixação.

APONTE A
CÂMERA DE SEU
CELULAR PARA O
QR CODE E BAIXE
A **CALCULADORA
DE FOLGAS**



ATENÇÃO - A instalação deve ser feita por profissional capacitado, seguindo as indicações do Manual de Montagem. Os Manuais de Montagem estão disponíveis no site www.tecvidro.com.br para download ou impressos.



Modelos com 4 e 2 folhas

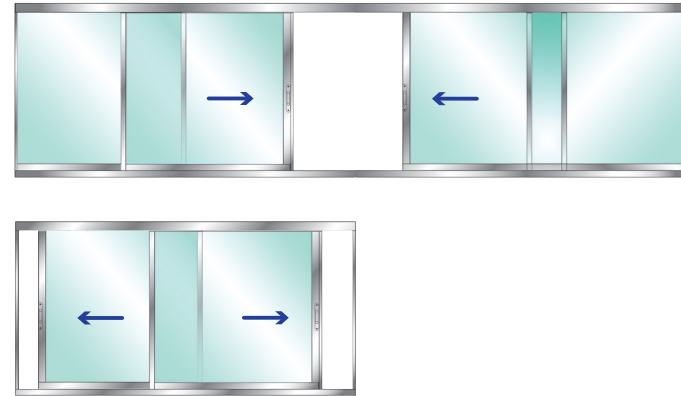

Folgas de altura

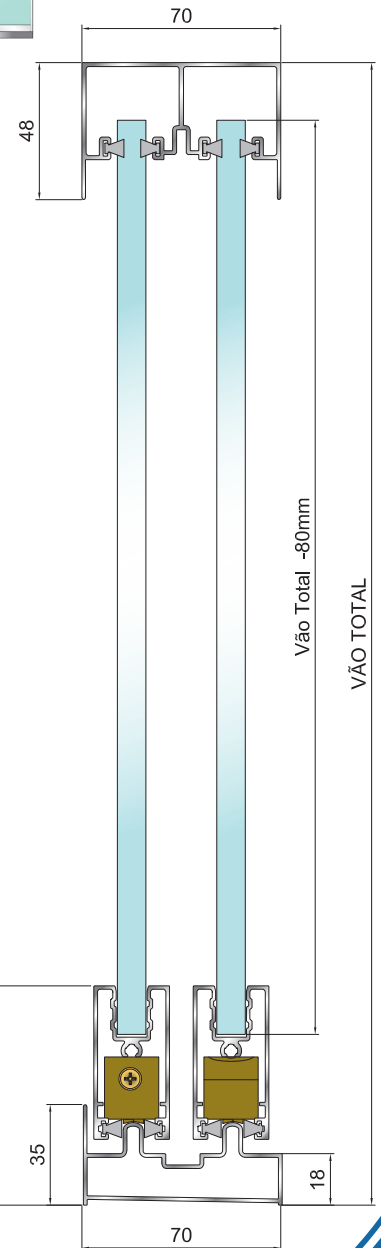

Borrachas e Escovas:
Melhor vedação.

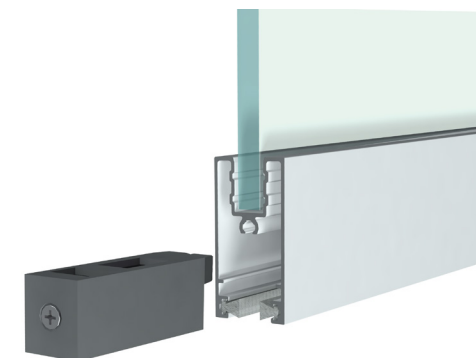
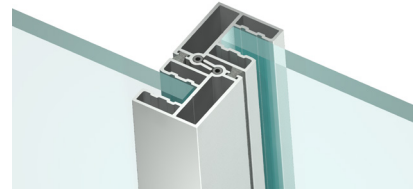

Roldanas com regulagem.

Versatik Division Janela

Fechamento de vão com desempenho

- Janela de vidro temperado com desempenho de Esquadria
- Vem com usinagem de fábrica

Para Vidros de **6, 8 e 10mm.**

Possui **vedação e estanquidade.**

Instalação simplificada, **sem** necessidade de **usinagem.**

Possui fechadura leve toque **touch.**

Para vidro **temperado e laminado.**



- | | | |
|----------------|---------------|----------------|
| | | |
| Preto | Branco | Cerejeira Real |
| | | |
| Champanhe 1002 | Natural Fosco | Linheiro Claro |



Versatik Truck

O kit de alta performance da Tec

- Inovador sistema de transferência de forças entre as peças móveis, possibilita a movimentação das portas simultaneamente



Produto Patentado.

Mecanismo embutido no trilho.



Movimentação Simultânea.



Abertura de até 2/3 do vão.



Parafusos em Aço Inox.



Para Vidros de 8 e 10mm.

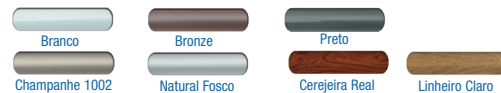

Conjunto de Altura para 10mm

CA2 - Conjunto para VE2:
2x Perfil U 10mm P-220
1x Perfil Vedação P-221

CA3 - Conjunto para VE3 ou VT3:
2x Perfil U 10MM P-220
2x Perfil Vedação P-221

CA6 - Conjunto para VE6 ou VT6:
2x Perfil U 10MM P-220
4x Perfil Vedação P-221
1x Perfil H Frontal P-222



Travas de Segurança.

VT3

1 Folha Fixa e 2 Móveis

Folgas laterais:

Sem fechadura: Vão + 120mm, dividido por 3 para fixo e portas de correr (largura das três peças iguais).

Com fechadura: Vão total dividido por 3. Do resultado adicionar 120mm no vidro nº 3.

Se adicionar puxador tipo "H" ou acessórios que não transpassam, considerar a distância de furação do mesmo e somar no dimensionamento do vidro nº 3.

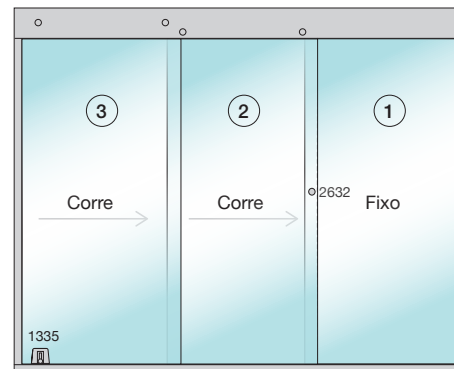

Folgas de altura

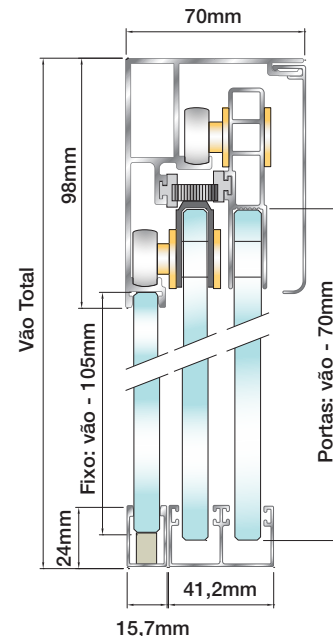

VT6

2 Folhas Fixas e 4 Móveis

Folgas laterais:

Sem fechadura: Vão + 240mm, dividido por 6 para fixos e portas de correr (largura das seis peças iguais).

Com fechadura: Vão total dividido por 6. Do resultado adicionar 120mm nas portas centrais. Se adicionar puxador tipo "H" ou acessórios que não transpassam, considerar a distância de furação do mesmo e somar no dimensionamento dos vidros nº 3.

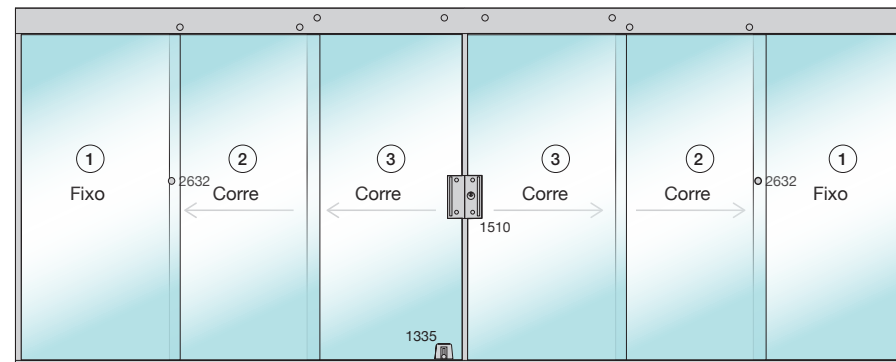

* Ferragens - sugestões de uso (não fazem parte do Kit).

Furação para Roldanas Vidros 8 e 10mm

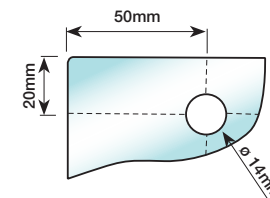

ATENÇÃO - A instalação deve ser feita por profissional capacitado, seguindo as indicações do Manual de Montagem. Os Manuais de Montagem estão disponíveis no site www.tecvidro.com.br para download ou impressos.



Versatik Evolution

A evolução do Versatik Truck

- Vedação com Borrachas e Escova, sem transpasse dos Vidros
- Fechadura embutida no Perfil

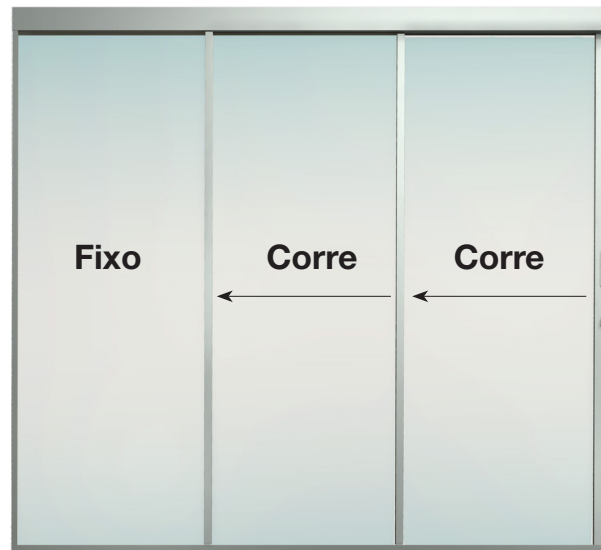

Folgas de altura

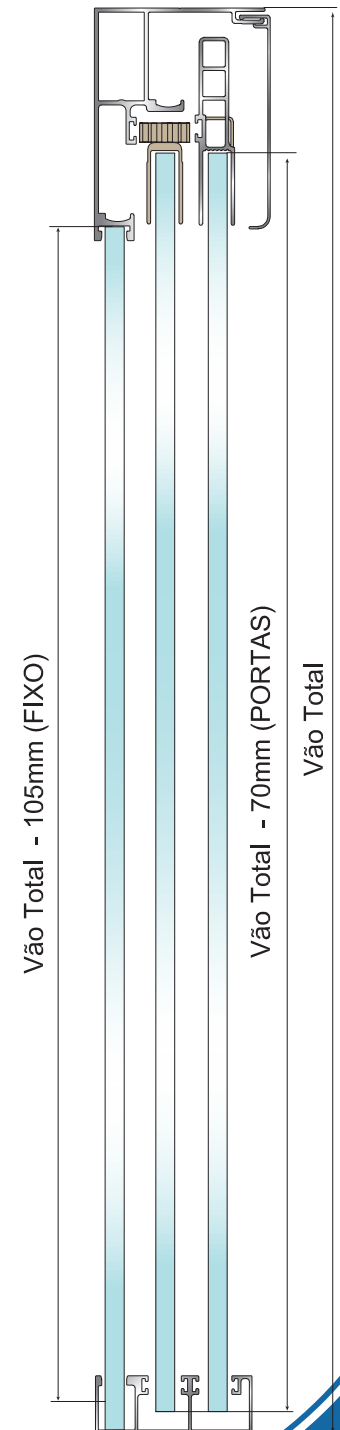

Possui desempenho **acústico** e **estanquidade**.



Para Vidros de **8 e 10mm**, **Temperado**.



Movimentação **simultânea** das folhas.



Acabamento diferenciado.



Produto Patentado.



Perfil Fechadura:
Perfil para Temperado ou Laminado com Fechadura embutida.



Borrachas e Escovas:
Melhor vedação.



- | | | | |
|----------------|---------------|----------------|----------------|
| | | | |
| Branco | Bronze | Cerejeira Real | Linheiro Claro |
| | | | |
| Champagne 1002 | Natural Fosco | Preto | |



Duo Safe

Kit Box p/ vidros laminado e temperado

- Roldanas com um exclusivo Sistema de Pinças
- Não usa furos e recortes nos vidros



Produto Patentado.



Projetado para garantir **segurança**.



Para Vidros de **6 e 8mm**.



Montagem rápida e prática.



Parafusos em **Aço Inox**.

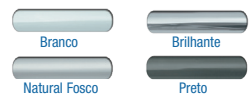

Exclusivo Sistema de Pinças:
Não precisa furar nem colar.



Segurança:
De acordo com a **NBR 14.207**.

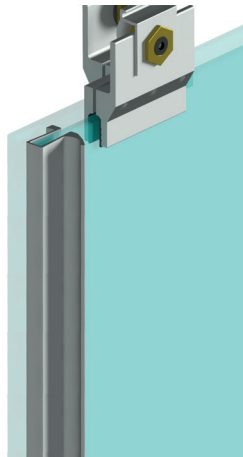

Puxador Linear:
Inteiro e fixado com silicone neutro.

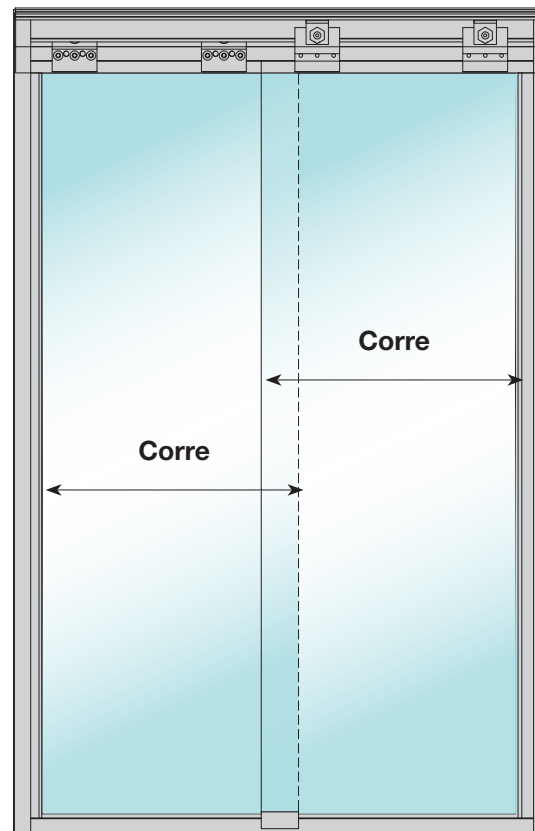

Folgas de altura

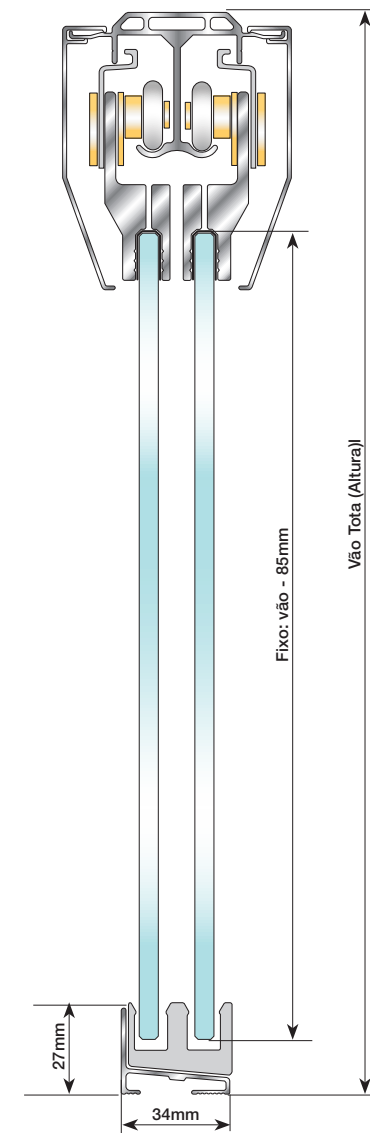

Durabilidade:
Sistema 100% inoxidável.

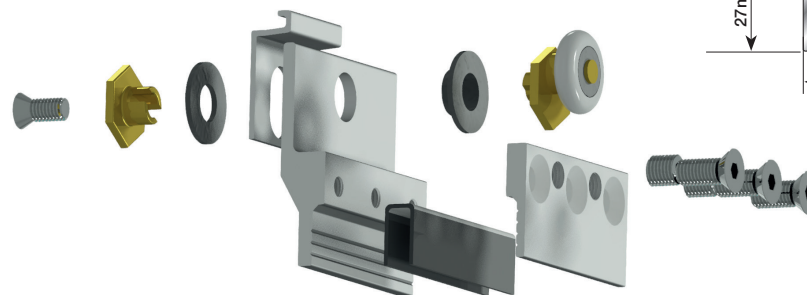

Carga Recomendada de Uso:
32Kg por Folha.



ATENÇÃO - A instalação deve ser feita por profissional capacitado, seguindo as indicações do Manual de Montagem. Os Manuais de Montagem estão disponíveis no site www.tecvidro.com.br para download ou impressos.



Tec Safe

Segurança e design exclusivo

- Pode utilizar vidros laminado ou temperado
- Permite o uso de vidros padrão sem recorte



Produto Patentado.



Para Vidros de **8mm, Laminado** ou **Temperado.**

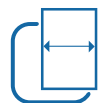

Para todas configurações tradicionais: **TS1, TS2 e TS3.**



Parafusos em **Aço Inox.**

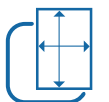

Permite o uso de **vidros tamanho padrão.**

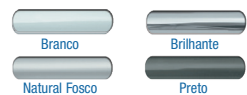

Exclusivo Sistema de Pinças:
Não precisa furar nem colar.



Exclusivo Sistema de Pinças:
Utiliza vidros temperado ou laminado.



ATENÇÃO - A instalação deve ser feita por profissional capacitado, seguindo as indicações do Manual de Montagem. Os Manuais de Montagem estão disponíveis no site www.tecvidro.com.br para download ou impressos.

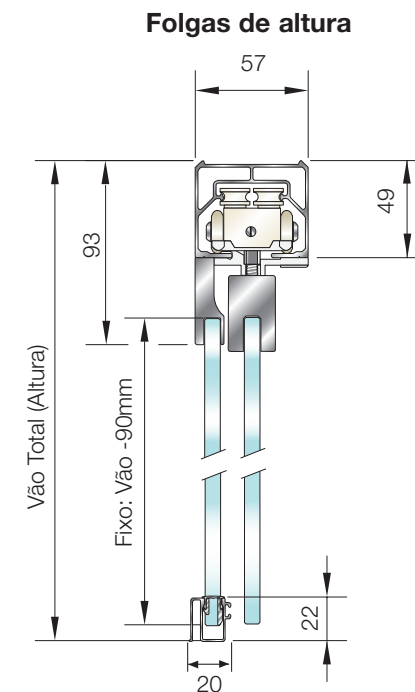
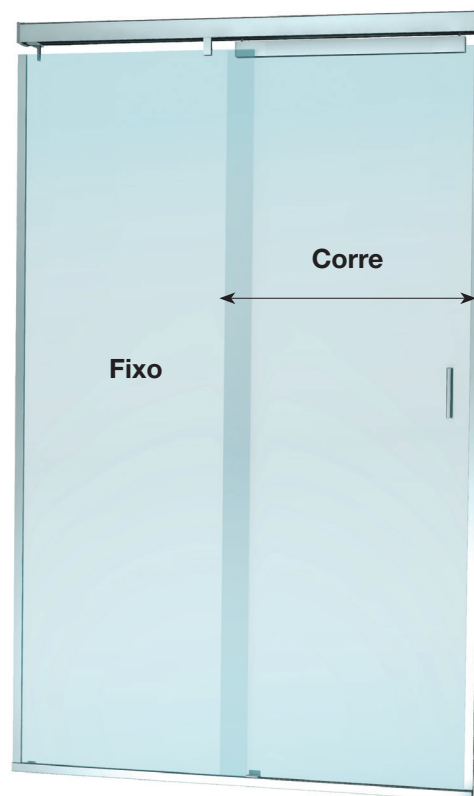

Vidros sem furação e recorte.



Royal Box

Elegante e minimalista

- Exclusivo alinhamento dos vidros
- Permite instalação de Piso-Teto



Produto Patenteado.



Para vidros de **8 e 10mm.**



Perfis e Roldanas **exclusivos.**



Parafusos em **Aço Inox.**



Projetado para garantir **segurança.**

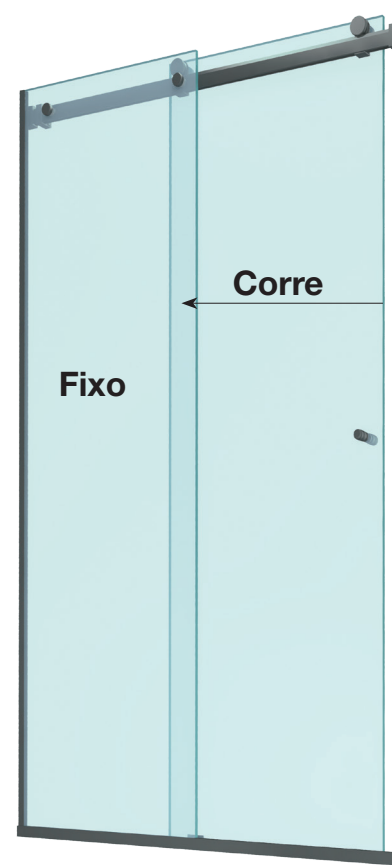
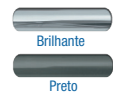

Permite instalação de Piso-Teto.

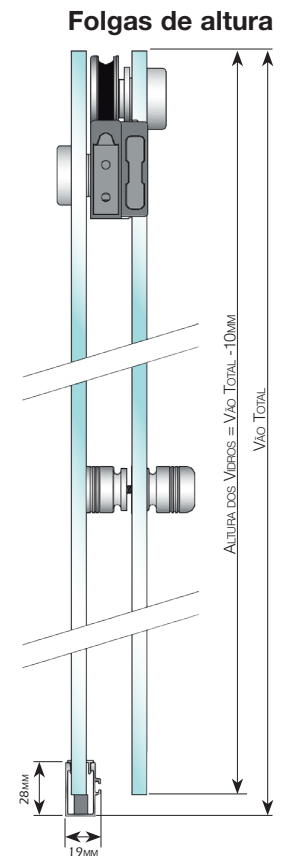

Roldana com regulagem e sem rolamento.

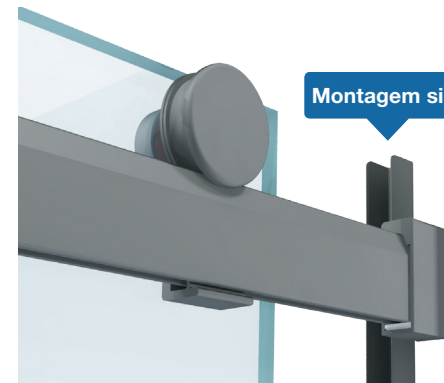

Montagem simples.



ATENÇÃO - A instalação deve ser feita por profissional capacitado, seguindo as indicações do Manual de Montagem. Os Manuais de Montagem estão disponíveis no site www.tecvidro.com.br para download ou impressos.



Transfer Box

Movimentação simultânea das portas

- Segue a tendência de arquitetura com linhas retas
- Ideal para pequenos vãos



Produto Patenteado.



Perfis exclusivos projetados para box.



Movimenta 2 portas ao mesmo tempo.



Parafusos em Aço Inox.



Montagem rápida e prática.



- Branco
- Brilhante
- Natural Fosco
- Preto

Travas de Segurança.

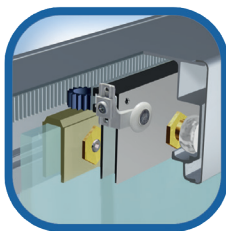

Puxador 2630 para furos de 14mm.

Perfil Suporte da Cremalheira em alumínio.

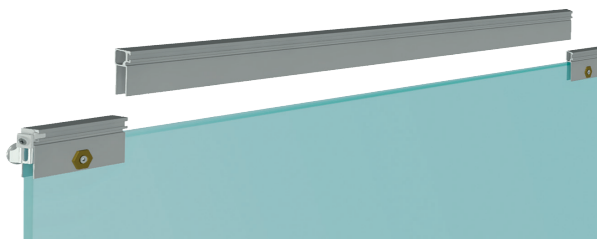

BT3

1 Folha Fixa e 2 Móveis

Folgas laterais:

Vão + 120mm dividido por 3 para fixo e portas de correr (largura das três peças iguais).

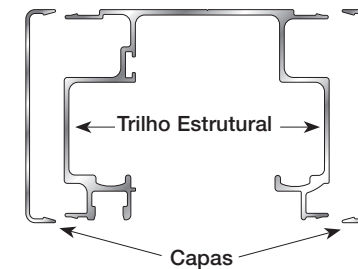
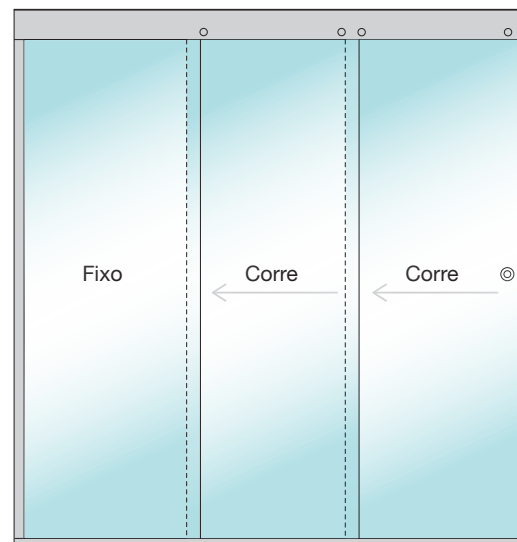

Folgas de altura 88mm

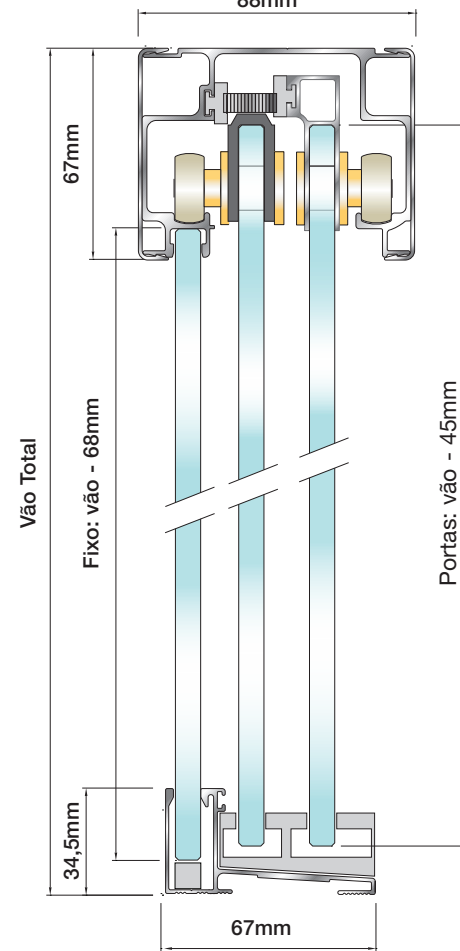

Furação para Roldana

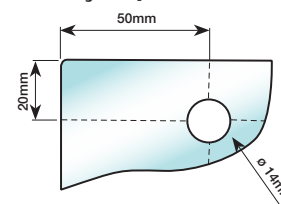

Furação para Puxador

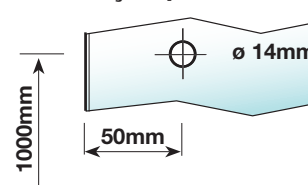

ATENÇÃO - A instalação deve ser feita por profissional capacitado, seguindo as indicações do Manual de Montagem. Os Manuais de Montagem estão disponíveis no site www.tecvidro.com.br para download ou impressos.



Multi Box

Design que valoriza as linhas retas

- Todos os perfis e acessórios foram reestilizados criando um conjunto atual e harmonioso



Para Vidros de **8mm**.



Perfis **exclusivos** projetados para **box**.



Montagem rápida e prática.



Parafusos em **Aço Inox**.



Projetado para garantir **segurança**.



Batedeira inferior com amortecedor de borracha.

- Modelos: **MF1**, **MF2**, **MF3** e **MC1**.

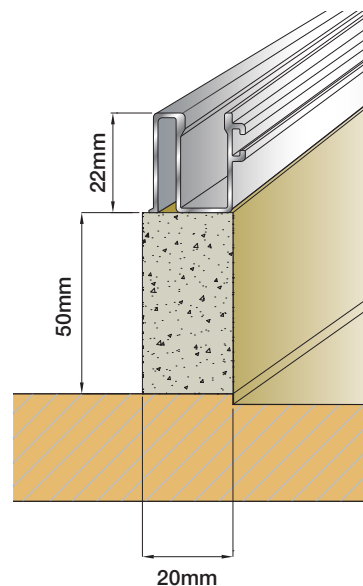

Detalhe do perfil guia inferior onde em determinadas regiões adota-se a colocação de pedra para a formação de um rebaixo extra.

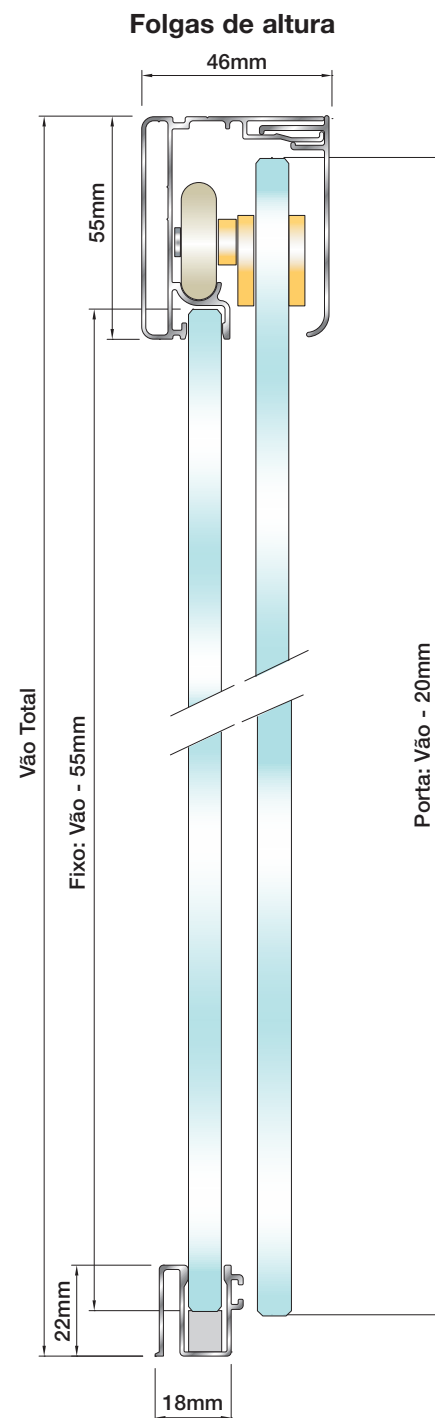

ATENÇÃO - A instalação deve ser feita por profissional capacitado, seguindo as indicações do Manual de Montagem. Os Manuais de Montagem estão disponíveis no site www.tecvidro.com.br para download ou impressos.

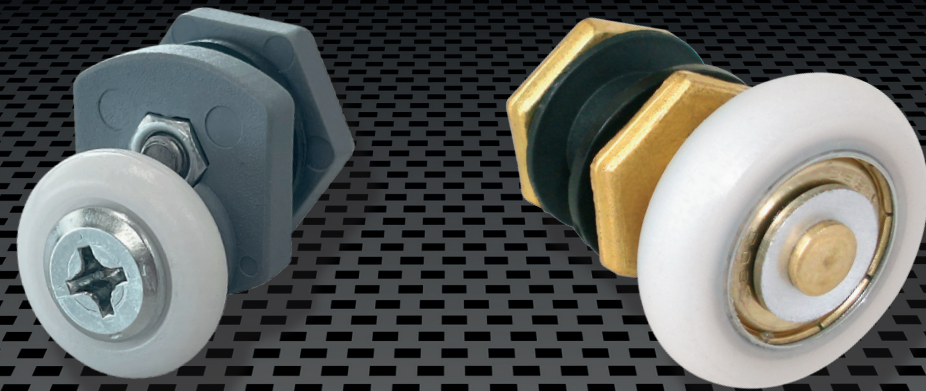

Roldanas

Tecnologia e qualidade Tec

- Para vidros de 6, 8 e 10mm
- Corpos em latão ou polímero
- Ajuste excêntrico de até 8mm*



Para Vidros de **6, 8 e 10mm**.



Ajuste Excêntrico de até **8mm***.



Corpos em **Latão ou Polímero**.



Componentes resistentes à **oxidação, salinidade e umidade**.



Tecnologias de rolagem **exclusivas**.



Melhor **Custo x Benefício** do mercado.

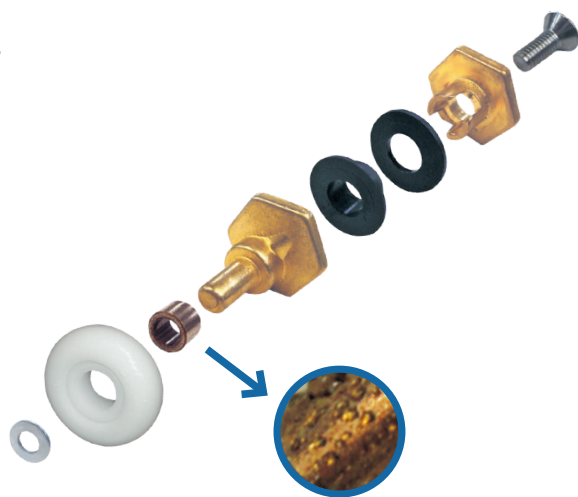

Bucha de Bronze Sinterizada com grafite:
 Garante a lubrificação da Roldana conforme realizada a movimentação das portas.

*Para Roldanas de Polímero

Linha Polímero



2125 PLB006
 Roldana PLB Excêntrica
 6mm - Bucha



2125 PLB008
 Roldana PLB Excêntrica
 8mm - Bucha



2125 PLR008
 Roldana PLR Excêntrica
 8mm



2125 PLR010
 Roldana PLR Excêntrica
 10mm

Linha Latão



R6
 Roldana Simples - Excêntrica
 6mm



2125 R8TV
 Roldana Simples - Excêntrica
 8mm



2125 R10TV
 Roldana Simples - Excêntrica
 10mm



2125 SI
 Roldana Simples - Rolamento
 Importado



OrbiTec Sacada

Alta durabilidade e total flexibilidade

- Produto de alto desempenho, possibilita a movimentação em vários ângulos, suporta grandes cargas de pressão e resistente às intempéries.

 **Produto Patenteado.**

 **Roldana** que se movimenta em **qualquer ângulo.**

 Para Vidros de **8 e 10mm.**

 Parafusos em **Aço Inox.**

 Vidros com largura de até **740mm.**

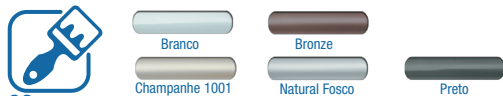
 Branco, Bronze, Champahe 1001, Natural Fosco, Preto

Segurança:
Produto robusto e projetado para alta durabilidade em qualquer ambiente.

Segurança:
De acordo com a **NBR 16.259.**



Durabilidade:
Sistema de Movimentação **sem rolamentos** de aço carbono.

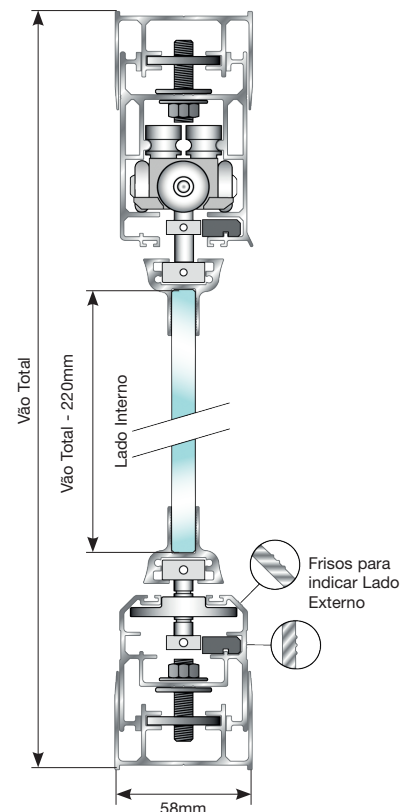

Acessórios de Canto 90°.
(Vendido à parte)



Sistema de Movimentação exclusivo. **Movimento suave em todas as direções.**

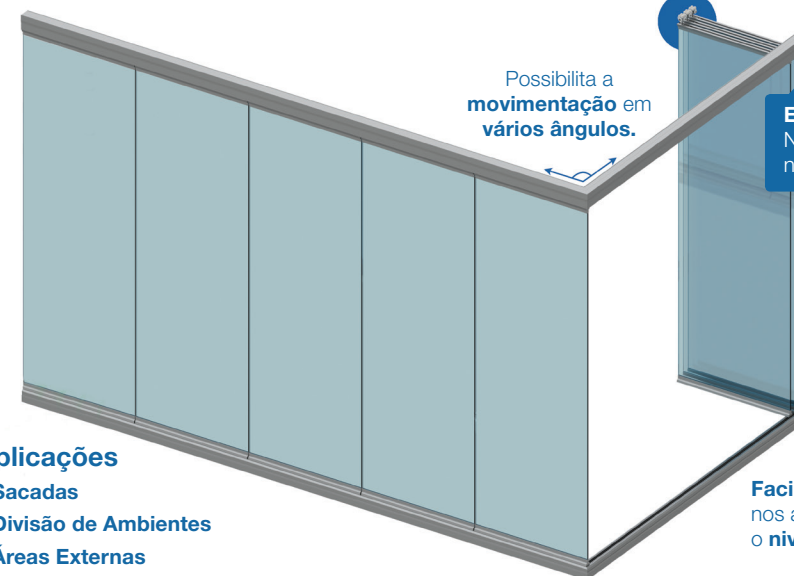

Aplicações

- ▶ Sacadas
- ▶ Divisão de Ambientes
- ▶ Áreas Externas
- ▶ Janelas

Facilidade e precisão nos ajustes de acordo com o **nivelamento** do piso.

 **ATENÇÃO** - A instalação deve ser feita por profissional capacitado, seguindo as indicações do Manual de Montagem. Os Manuais de Montagem estão disponíveis no site www.tecvidro.com.br para download ou impressos.



OrbiTec Pro

Produto para múltiplas soluções

- Indicado para ambientes internos e externos
- Ideal para pequenos e grandes vãos



Produto Patenteado.



Roldana que se movimenta com **maior** segurança e suavidade.



Para Vidros de **8 e 10mm.**



Parafusos em **Aço Inox.**

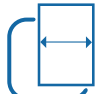

Vidros com largura de até **740mm.**



Perfil Inferior:
Mais facilidade para instalação.

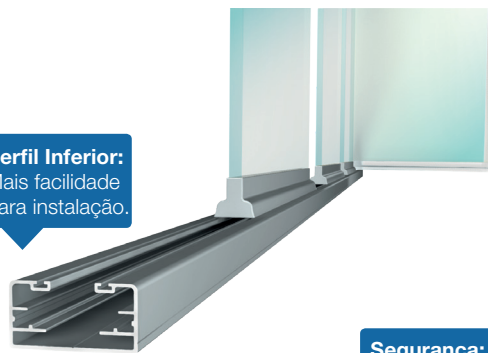

Segurança:
De acordo com a **NBR 16.259.**

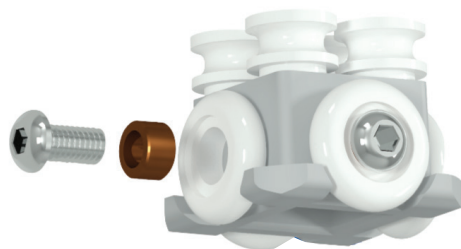

Folgas de altura

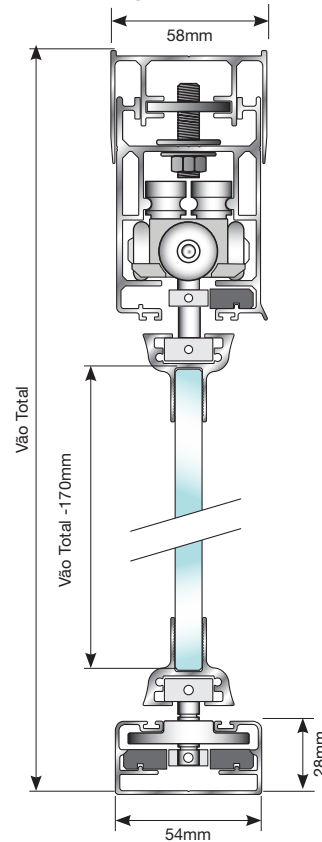

Montagem:
Instalação mais rápida do mercado.

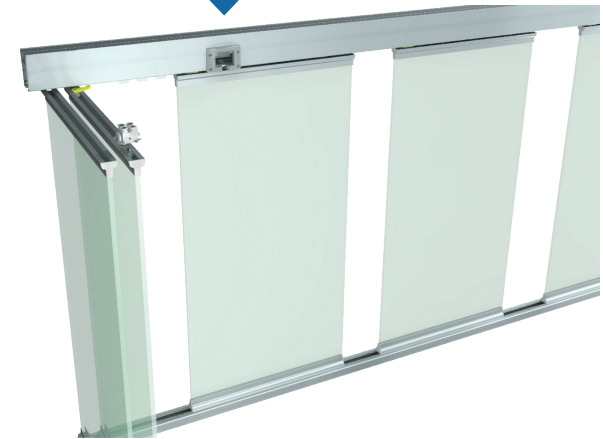

Sistema sem rolamentos:
Resistente a corrosão evitando manutenção.

Estética:
Não utiliza Chapa Guia na caixa de saída.



Aplicações

- ▶ Sacadas
- ▶ Divisão de Ambientes
- ▶ Áreas Externas
- ▶ Janelas



ATENÇÃO - A instalação deve ser feita por profissional capacitado, seguindo as indicações do Manual de Montagem. Os Manuais de Montagem estão disponíveis no site www.tecvidro.com.br para download ou impressos.



Envidraçamento Sacada

Produto para Especialistas

- Mais precisão na montagem, melhor acabamento e menor custo na instalação



Instalação de **Sacadas, Janelas, etc.**



Para vidros de **8 e 10mm.**



Parafuso e Roldanas **em Aço Inox.**



O melhor **custo/benefício** do mercado.



Projetado para garantir **segurança.**



 Branco	 Bronze	 Champagne 1001
 Champagne 1002	 Natural Fosc	 Preto

* Só para 6 metros

Detalhe nos encaixes das roldanas evitam caimento dos vidros.
• Fator de Segurança

“Pingadeira” impede retorno de água na parte superior.
• Melhor vedação

Posição das escovas no lado externo dos perfis.
• Maior vedação contra entrada de água

Perfis posicionam o vidro fora do centro melhorando o fator de vedação.
• Perfil tubular com melhor estrutura contra torções ou deformações

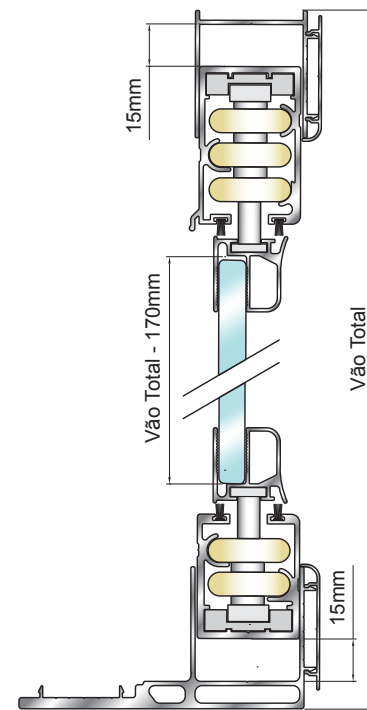
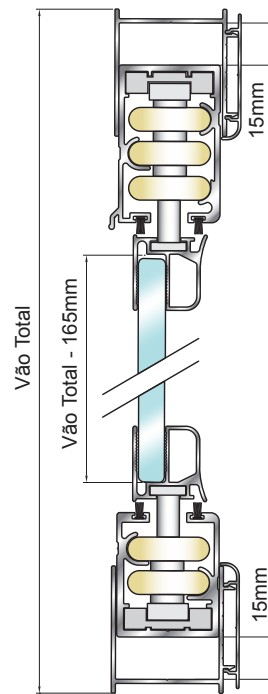
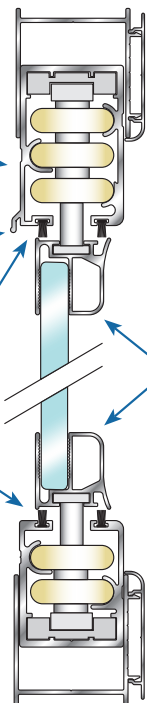

Folgas de altura



Caixa de Saída Superior sem Chapa Guia.



Fechadura com Contra 3601.

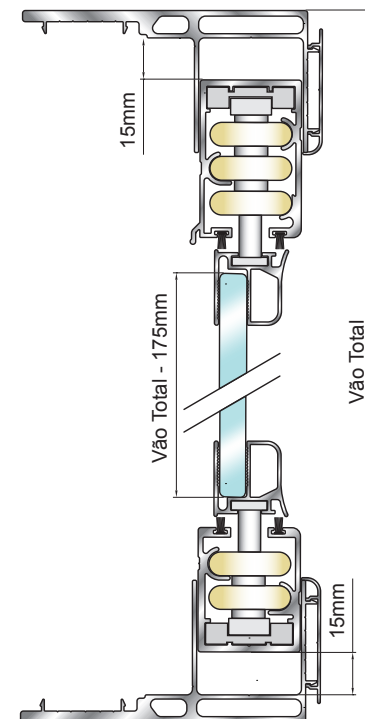



FortCorp

Guarda corpo

- Melhor custo benefício, montagem simples e segura
- Borrachas de ajuste, acabamento e vedação



Perfil Central com capa de acabamento

Segurança:
De acordo com a **NBR 14.718.**



Perfis para **sobrepor e embutir.**



Para vidros de **12mm (6+6), 16mm (8+8) e 20mm (10+10).**



Projetado para garantir **segurança.**



CORES ESPECIAIS SOB CONSULTA

Branco
 Natural Fosco
 Preto

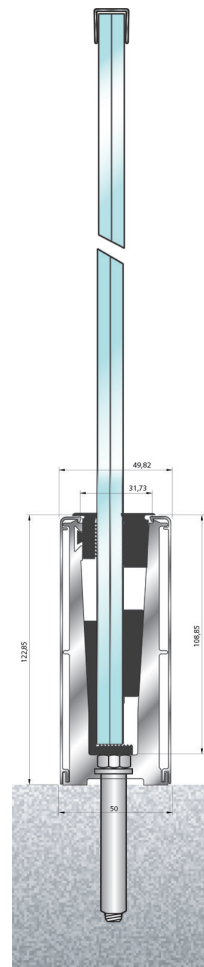

Perfil Central com furos escareados.

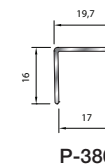
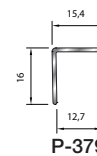
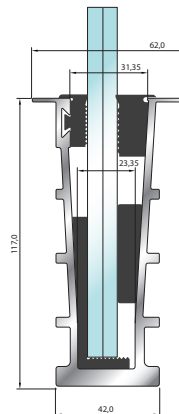

Perfis de Acabamento em barras de 6.000mm. (Opcional)

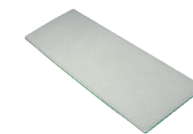

Chapa de Acabamento. (Opcional)

Linha Completa de Perfis e Sistemas Tec

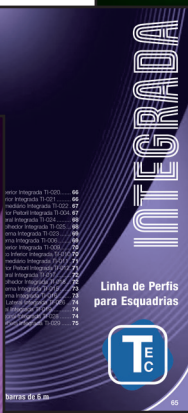
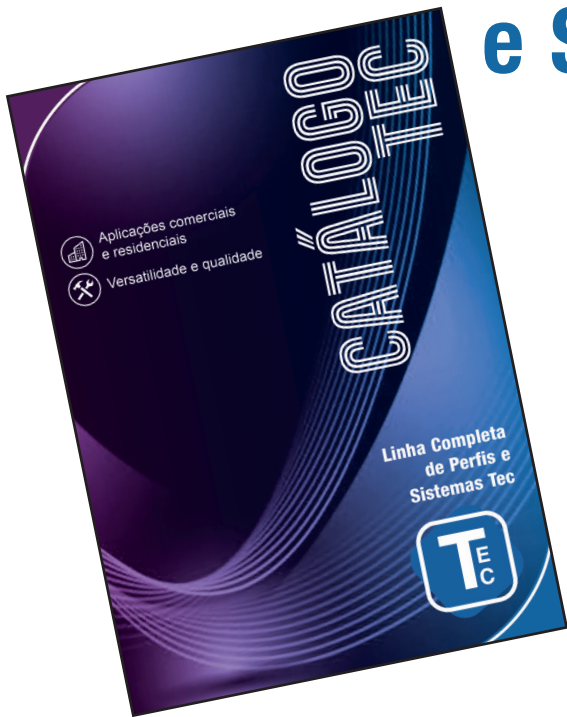

Sistemas Tec

TEC

Índice

Divisão	89
Tec Vidro	91
Acabado Laminado	93
Duo Safe	95
Tec Safe	97
Tríplice Box	99
Multi Box	101
Tradicional	103
Polímero	105
Lábio	105
Sacada	107
Piso	109
Sacada	111
113	113



APONTE A
CÂMERA DE SEU
CELULAR PARA O
QR CODE E BAIXE
O CATÁLOGO



